



mertenTM

Wiser Home Touch

Schneider
ElectricTM

SAFETY INFORMATION / INFORMATIONS RELATIVES À LA SÉCURITÉ /
SICHERHEITSHINWEISE / VEILIGHEIDSINFORMATIE /
SIKKERHEDSOPLYSNINGER / SÄKERHETSINFORMATION /
TURVALLISUUSTIETOJA / SIKKERHETSINFORMASJON /
ИНФОРМАЦИЯ О БЕЗОПАСНОСТИ / ҚАУІПСІЗДІК АҚПАРАТЫ /
INFORMACIÓN DE SEGURIDAD / INFORMAZIONI SULLA SICUREZZA

- EN** Read these instructions carefully and look at the equipment to become familiar with the device before trying to install, operate, service or maintain it.
- FR** Lisez attentivement les consignes et inspectez l'appareil pour vous familiariser avec avant de l'installer, de l'utiliser ou d'effectuer des tâches d'entretien ou de maintenance.
- DE** Lesen Sie sich diese Anweisungen genau durch, um sich mit dem Gerät vertraut zu machen, bevor Sie versuchen, es einzurichten, zu verwenden, zu warten oder instand zu halten.
- NL** Lees deze instructies zorgvuldig door en bekijk de apparatuur om vertrouwd te raken met het apparaat alvorens het te installeren, te gebruiken of er onderhoud aan te plegen.
- DA** Læs disse instruktioner grundigt igennem, og se på enheden for at gøre dig bekendt med den, før du forsøger at installere, betjene, servicere eller vedligeholde den.
- SV** Läs dessa instruktioner ingående och titta på utrustningen för att bekanta dig med enheten innan du försöker installera, använda, serva eller underhålla den.
- FI** Lue nämä ohjeet läpi huolellisesti ja tutustu laitteeseen, jotta tunnet sen, ennen kuin asennat, käytät, huollat tai ylläpidät sitä.
- NO** Les disse instruksjonene nøye, og se på utstyret for å bli kjent med enheten, før du prøver å installere, kjøre, vedlikeholde eller utføre service på den.
- RU** Внимательно прочитайте инструкции, чтобы ознакомиться с устройством, перед тем как начинать его монтаж, эксплуатацию или обслуживание.
- KK** Құрылғыны орнату, пайдалану, қызмет көрсету немесе қолдау көрсету әрекеті алдында онымен танысу үшін осы нұсқауларды мұқият оқыңыз және жабдықты қараңыз.
- ES** Lea cuidadosamente estas instrucciones y observe el equipo para familiarizarse con el dispositivo antes de intentar instalarlo, hacerlo funcionar, repararlo o realizar tareas de mantenimiento.
- IT** Leggere con attenzione le istruzioni ed esaminare l'apparecchiatura per acquisire familiarità con il dispositivo prima di provare l'installazione, l'utilizzo e interventi di assistenza o manutenzione.

▲ DANGER / DANGER / GEFAHR

HAZARD OF ELECTRIC SHOCK, EXPLOSION, OR ARC FLASH

Safe electrical installation must be carried out only by skilled professionals. Skilled professionals must prove profound knowledge in the following areas:

- Connecting to installation networks
- Connecting several electrical devices
- Laying electric cables
- Safety standards, local wiring rules and regulations

Failure to follow these instructions will result in death or serious injury.

RISQUE DE DÉCHARGE ÉLECTRIQUE, D'EXPLOSION OU DE COUP D'ARC

L'installation électrique répondant aux normes de sécurité doit être effectuée par des professionnels compétents. Les professionnels compétents doivent justifier de connaissances approfondies dans les domaines suivants:

- Raccordement aux réseaux d'installation
- Raccordement de différents appareils électriques
- Pose de câbles électriques
- Normes de sécurité, règles et réglementations locales pour le câblage

Le non-respect de ces instructions peut entraîner la mort ou de graves blessures.

LEBENSGEFAHR DURCH ELEKTRISCHEN SCHLAG, EXPLOSION ODER LICHTBOGEN

Eine sichere Elektroinstallation muss von qualifizierten Fachkräften ausgeführt werden. Qualifizierte Fachkräfte müssen fundierte Kenntnisse in folgenden Bereichen nachweisen:

- Anschluss an Installationsnetze
- Verbindung mehrerer elektrischer Geräte
- Verlegung von Elektroleitungen
- Sicherheitsnormen, örtliche Anschlussregeln und Vorschriften

Die Nichtbeachtung dieser Anweisungen führt zum Tod oder zu schweren Verletzungen.

▲ GEVAAR / VAARA / FARA

RISICO OP ELEKTRISCHE SCHOK, EXPLOESIE, OF OVERSLAG

Een veilige elektrische installatie mag alleen worden uitgevoerd door ervaren deskundigen. Ervaren deskundigen moeten een grondige kennis hebben van het volgende:

- Aansluiting op elektriciteitsnetwerken
- Aansluiten van meerdere elektrische apparaten
- Leggen van elektrische leidingen
- Veiligheidsnormen, lokale bedravingsvoorschriften

Als deze instructies niet worden opgevolgd, heeft dit de dood of ernstige verwondingen tot gevolg.

SÄHKÖISKUN, RÄJÄHDYKSEN TAI VALOKAAREN VAARA

Turvallisen sähköasennuksen saavat suorittaa vain pätevät ammattilaiset. Pätevillä ammattilaisilla täytyy olla perusteelliset tiedot seuraavilla alueilla:

- Asennusverkkoihin yhdistäminen
- Useiden sähkölaitteiden yhdistäminen
- Sähkökaapeleiden asentaminen
- Turvallisuusstandardit, paikalliset johdotussäännöt ja määräykset

Näiden ohjeiden noudattamatta jättämisen seurauksena on kuolema tai vakavia vammoja.

RISK FÖR ELEKTRISK SHOCK, EXPLOSION OCH BAGBLIXT

Av säkerhetsskäl skall installation endast utföras av utbildad personal. Utbildad personal skall uppvisa djupt kunnande inom följande områden:

- Anslutning till installationsnätverk
- Anslutning till flera elektriska apparater
- Dragnig av elkablar
- Säkerhetsstandarder samt lokala kabeldragningsföreskrifter och regler

Om dessa instruktioner inte åtföljs kan det resultera i allvarliga skador eller dödsfall.

▲ FARE / FARE / PELIGRO

FARE FOR ELEKTRISK STØT, EKSPLOSION ELLER OVERLEDNING

Sikre elektroinstallasjoner må utelukkende utføres av autoriserte installatører. De autoriserte installatørene må ha inngående kunnskap innen følgende områder:

- Tilkobling til installasjonsnettverk
- Tilkobling av flere elektriske enheter
- Legging av elektriske kabler
- Sikkerhetsstandarder, lokale kabeltrekregler og reguleringer

Hvis disse instruksene ikke overholdes vil dette resultere i dødsfall eller alvorlige skader.

FARE FOR ELEKTRISK STØD, EKSPLOSION ELLER LYNEFFEKT

Sikker elektrisk installation må kun foretages af kvalificerede fagfolk. Kvalificerede fagfolk skal bevise indgående kendskab inden for de følgende områder:

- Tilslutning til installation-snet
- Tilslutning af flere elektriske anordninger
- Elektrisk kabelføring
- Sikkerhedsstandarder, lokale regler og bestemmelser vedrørende ledningsføring

Manglende overholdelse af disse anvisninger vil kunne resultere i alvorlig personskade og endda døden.

PELIGRO DE DESCARGA ELÉCTRICA, EXPLOSIÓN O ARCO ELÉCTRICO

Solo profesionales especializados deben llevar a cabo una instalación eléctrica segura. Los profesionales especializados deben demostrar un amplio conocimiento en las siguientes áreas:

- Conexión a redes de instalación
- Conexión de varios dispositivos eléctricos
- Tendido de cables eléctricos
- Normas de seguridad, normativas y reglamentos sobre cableado

El incumplimiento de estas instrucciones puede causar la muerte o lesiones graves.

▲ PERICOLO / ОПАСНО / ҚАУІП

PERICOLO DI SCOSSE ELETTRICHE, ESPLOSIONI O ARCHI ELETTRICI

Un'installazione elettrica sicura deve essere eseguita solo da professionisti qualificati. I professionisti qualificati devono dimostrare una profonda conoscenza nelle seguenti aree:

- Connessione a reti di installazione
- Collegamento di più dispositivi elettrici
- Posa di cavi elettrici
- Standard di sicurezza, norme e regolamenti locali sui cablaggi

La mancata osservanza di queste istruzioni può determinare la morte o lesioni gravi.

ОПАСНОСТЬ ПОРАЖЕНИЯ ЭЛЕКТРИЧЕСКИМ ТОКОМ, ВЗРЫВА ИЛИ ДУГОВОГО ПРОБОЯ

Установка электрооборудования должна выполняться только квалифицированными специалистами с соблюдением правил техники безопасности. Квалифицированные специалисты должны иметь подтвержденную квалификацию в следующих областях:

- Подключение к электрическим сетям
- Соединение электрических устройств
- Прокладка электрических кабелей
- Правила техники безопасности, местные нормы и правила электромонтажа

Несоблюдение этих указаний приводит к смерти или серьезным травмам.

ТОҚ СОҒУ, ЖАРЫЛУ НЕМЕСЕ ЭЛЕКТР ДОҒАСЫНЫҢ ТҰТАНУ ҚАУІПІ

Қауіпсіз электр орнатуын білікті мамандар ғана жүргізуі қажет. Білікті мамандардың келесі жағдайларды жетік білуі керек:

- Орнату желілеріне жалғау
- Бірнеше электр құрылғыларын жалғау
- Электр кабельдерін орнату
- Қауіпсіздік стандарттары, жергілікті электр сымдарын жалғау ережелері мен қағидалары

Осы нұсқауларды орындамасаңыз, өлім жағдайына немесе ауыр жарақаттарға әкеледі.

- ✓
- ✓
- ✓

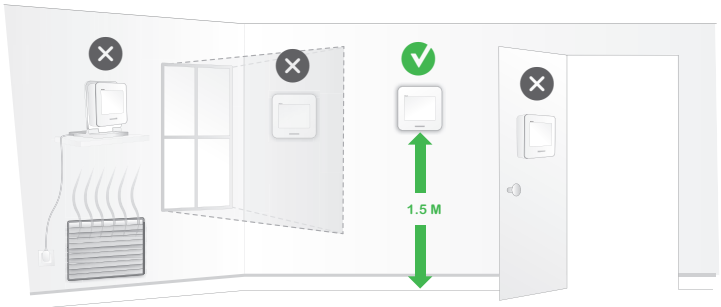

Wiser Home Touch with Stand



Wiser Home Touch with Wall Mount





- EN** Wiser Home Touch installation with stand
- FR** Wiser Home Touch installation avec support
- DE** Wiser Home Touch mit Standfuß
- NL** Wiser Home Touch installatie met standaard
- DA** Wiser Home Touch installation med stativ
- SV** Wiser Home Touch installasjon med stativ
- FI** Wiser Home Touch asennus jalustalla
- NO** Wiser Home Touch installation med stativ
- RU** Wiser Home Touch установка с подставкой
- KK** Wiser Home Touch стенден орнату
- ES** Wiser Home Touch instalación con soporte
- IT** Wiser Home Touch installazione con supporto

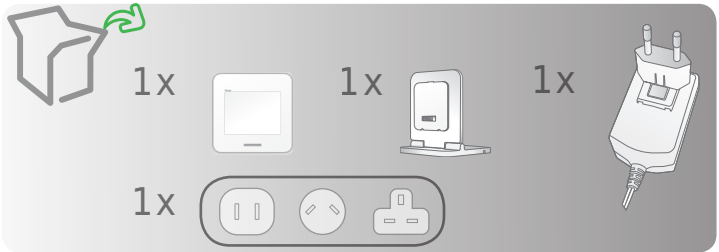

1

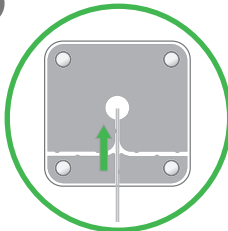

2

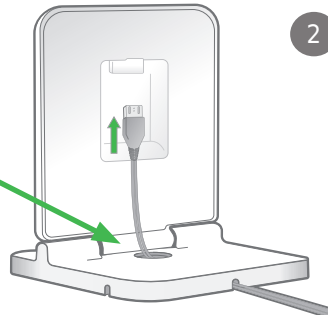

3

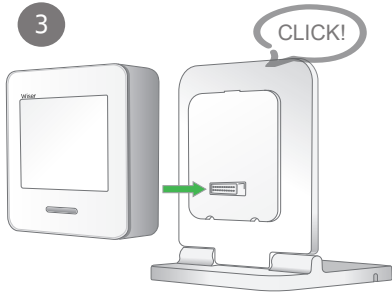

4

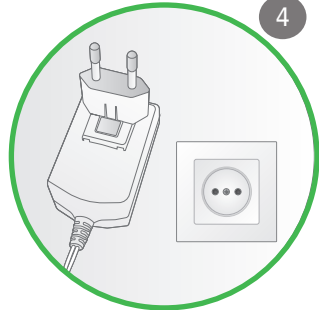

5

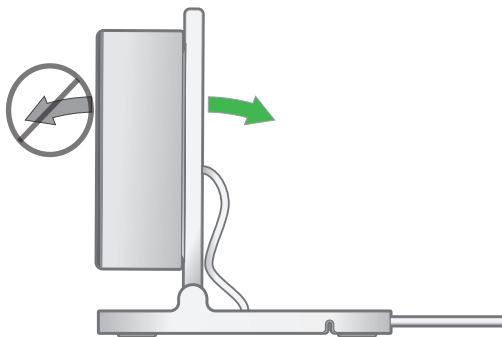

6





- EN** Wiser Home Touch with wall mount
Installation with power converter
- FR** Wiser Home Touch pour installation murale
Installation avec transformateur de tension
- DE** Wiser Home Touch mit Wandbefestigung
Installation mit Netzteil
- NL** Wiser Home Touch met muurbevestiging
Installatie met stroomomvormer
- DA** Montering af Wiser Home Touch med vægbeslag
Installation med strømomformer
- SV** Wiser Home Touch med väggfäste
Installation med spänningsomvandlare
- FI** Wiser Home Touch seinäkiinnityksellä
Asennus muuntajalla
- NO** Wiser Home Touch med veggmontering
Installasjon med strømtransformator
- RU** Wiser Home Touch с настенной установкой
Установка с преобразователем питания
- KK** Қабырға бекітпесі бар Wiser Home Touch
Қуат түрлендіргішімен орнату
- ES** Wiser Home Touch con montaje en la pared
Instalación con convertidor de corriente
- IT** Wiser Home Touch con montaggio a parete
Installazione con convertitore di alimentazione

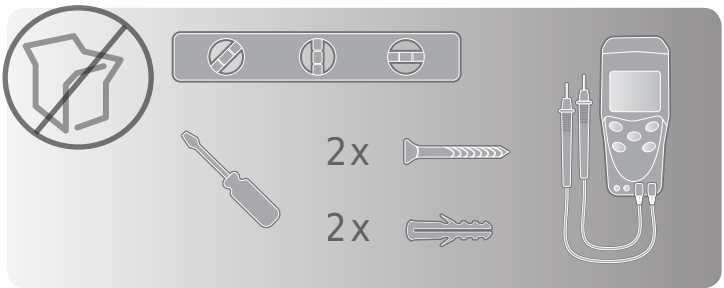
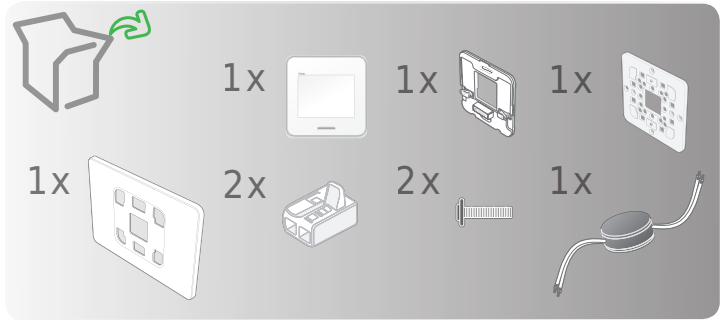

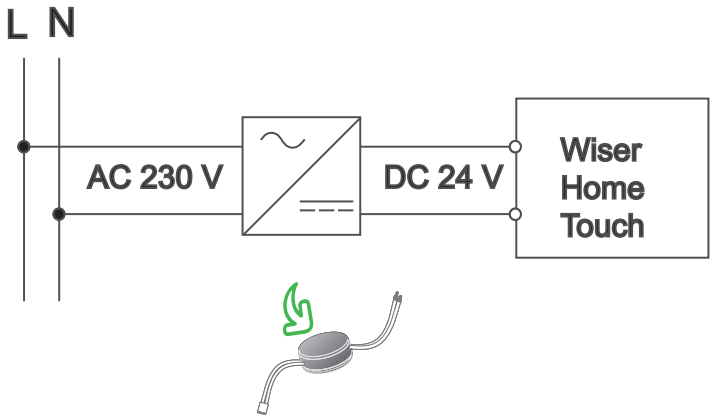

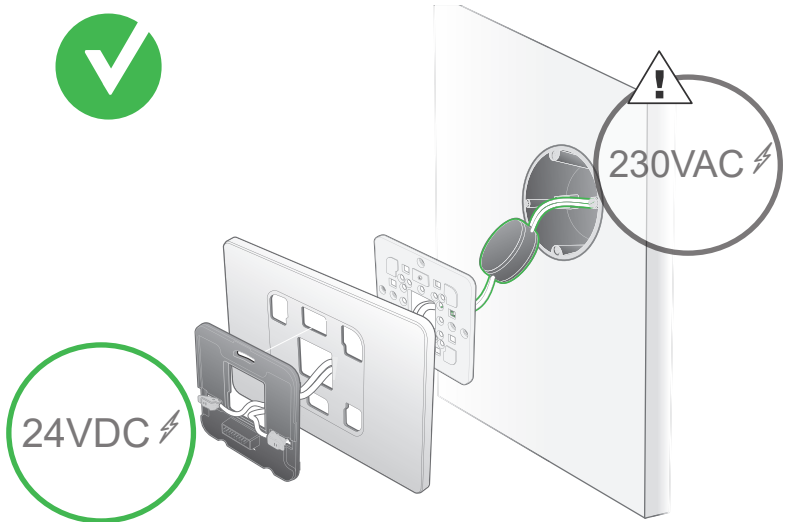
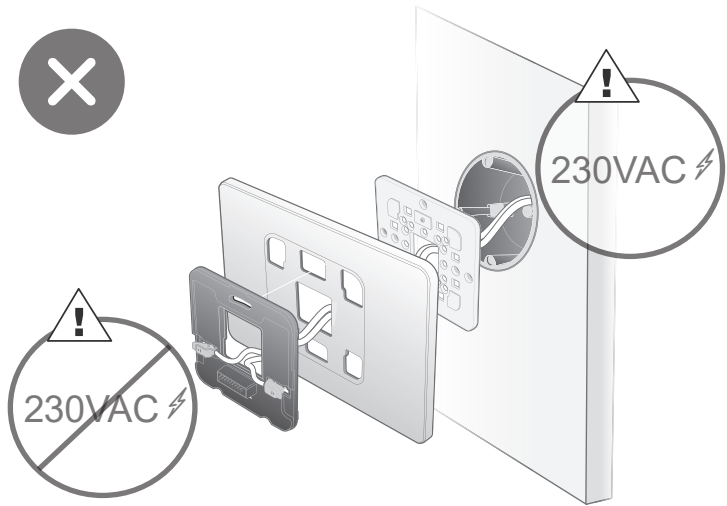

1

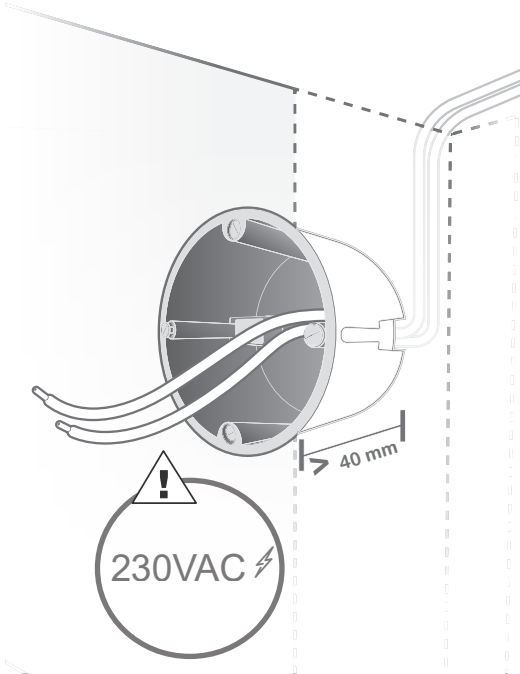
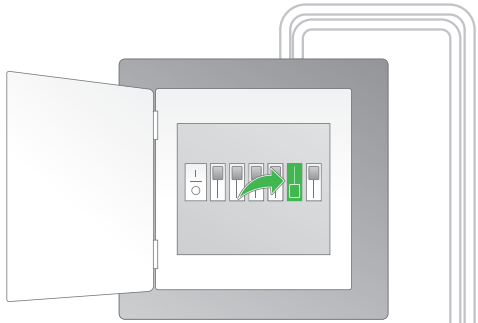

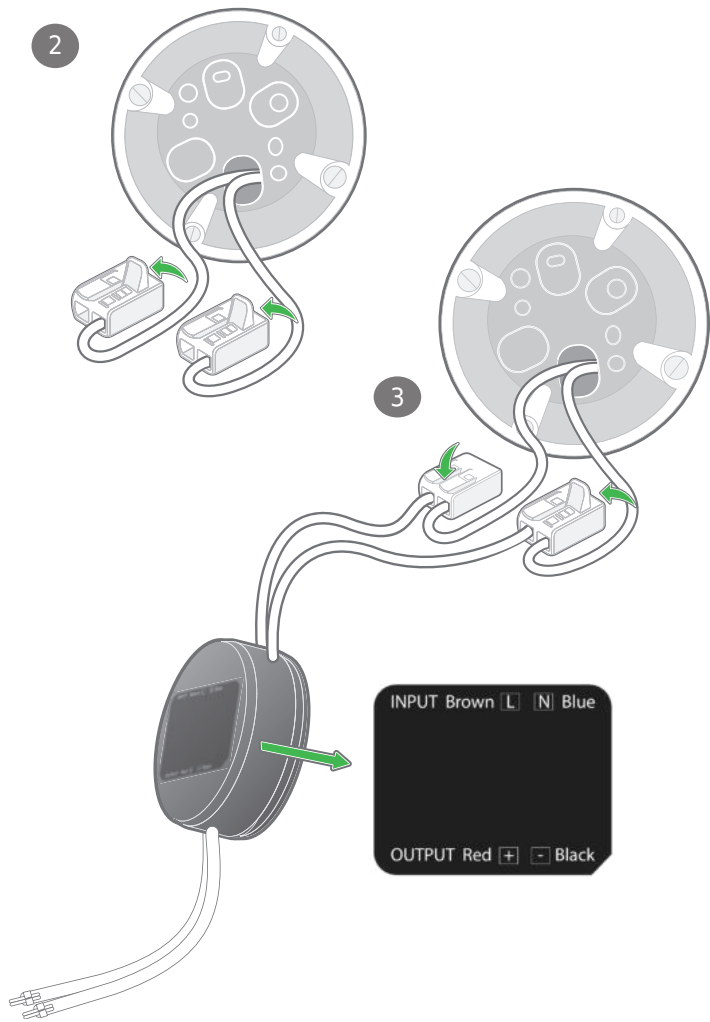

4

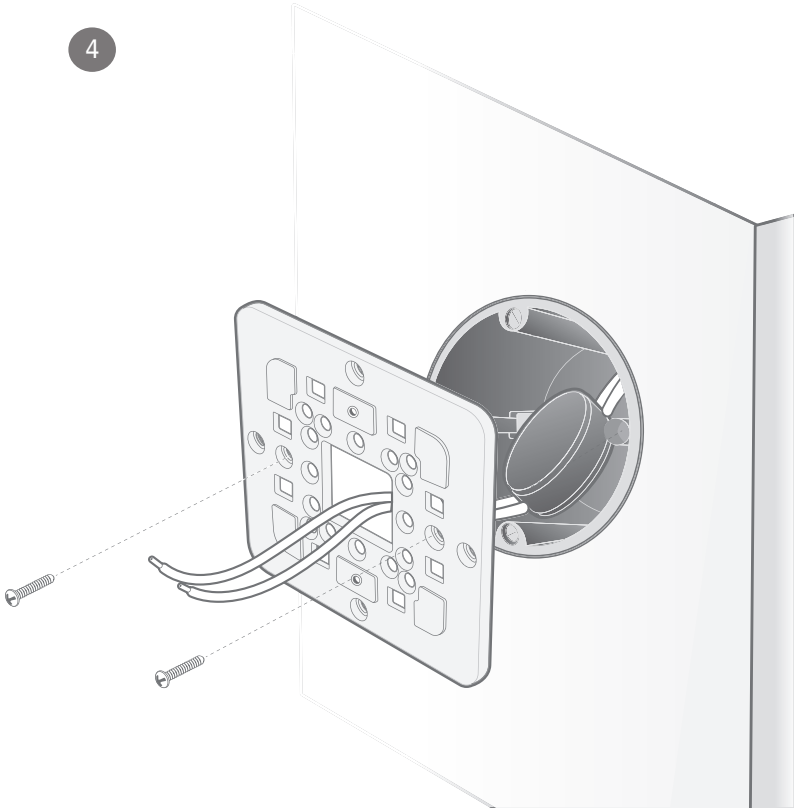



5

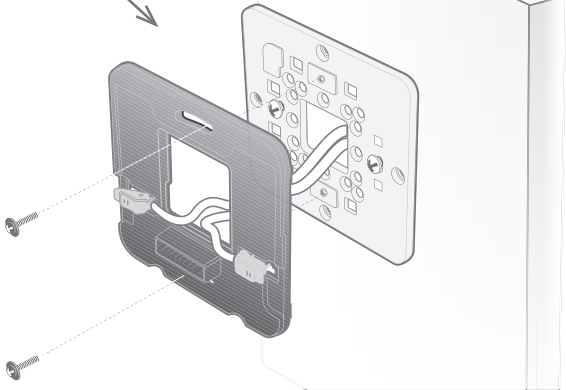

6

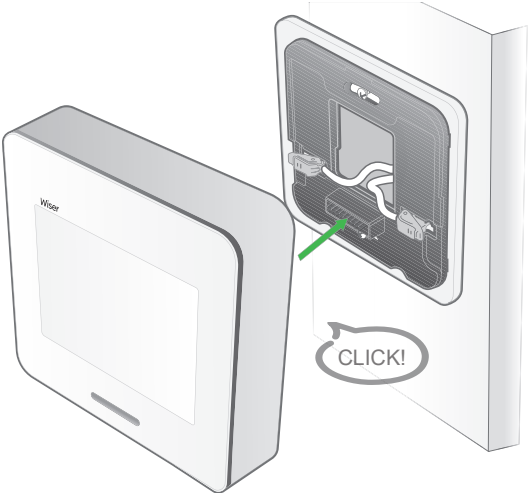

7





FR

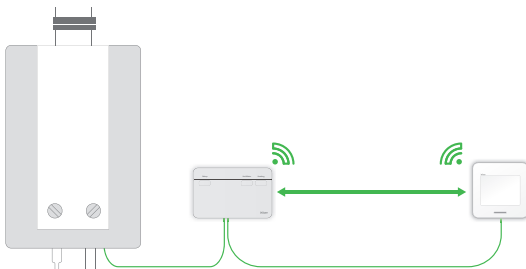

EN Wiser Home Touch with wall mount
Replacing existing wired thermostat

FR Wiser Home Touch pour installation murale
Remplacement du thermostat câblé existant

DE Wiser Home Touch mit Wandbefestigung
Austausch des vorhandenen Thermostats

NL Wiser Home Touch met muurbevestiging
Bestaande bedrade thermostaat vervangen

DA Montering af Wiser Home Touch med vægbeslag
Udskiftning af den eksisterende termostat

SV Wiser Home Touch med väggfäste
Ersätter befintlig termostat med kabelanslutning

FI Wiser Home Touch seinäkiinnityksellä
Olemassa olevan langallisen termostaatin korvaaminen

NO Wiser Home Touch med veggmontering
Erstatter eksisterende termostat via kabel

RU Wiser Home Touch с настенной установкой
Замена имеющегося проводного термостата

KK Қабырға бекітпесі бар Wiser Home Touch
Бар сымды термостатты ауыстыру

ES Wiser Home Touch con montaje en la pared
Sustitución del termostato cableado existente

IT Wiser Home Touch con montaggio a parete
Sostituzione del termostato cablato esistente

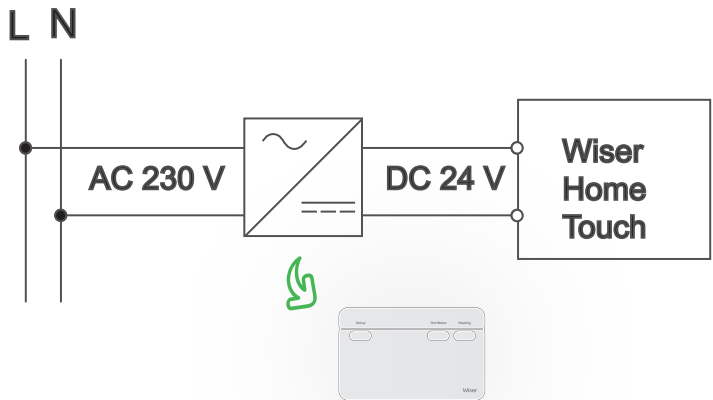



FR

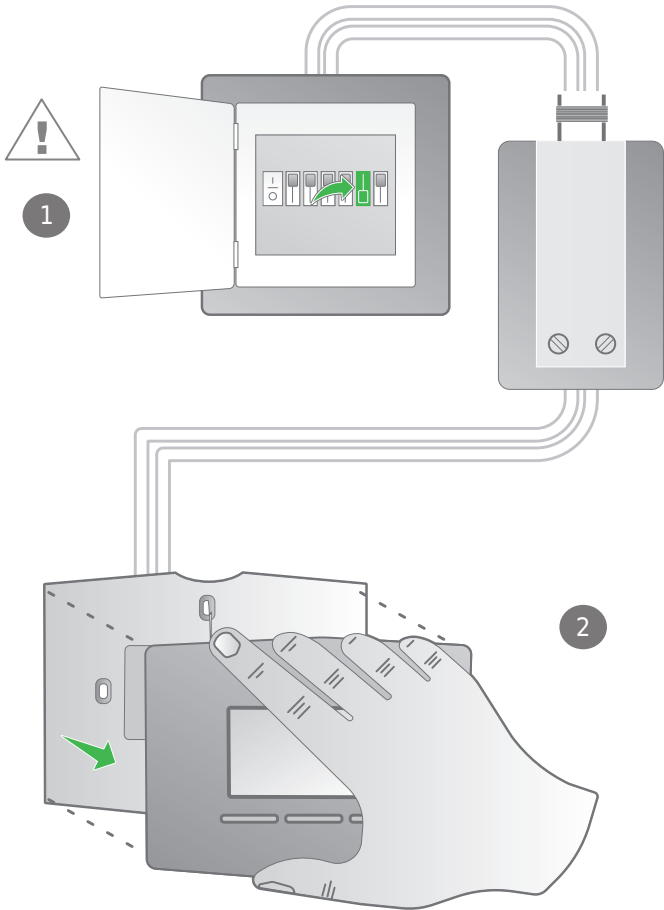



3



4

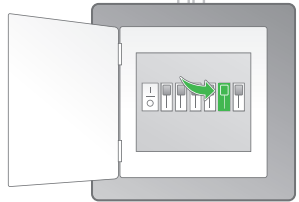

24VDC ⚡



5





FR

6

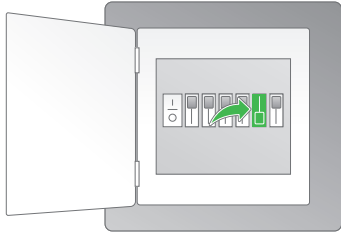

7

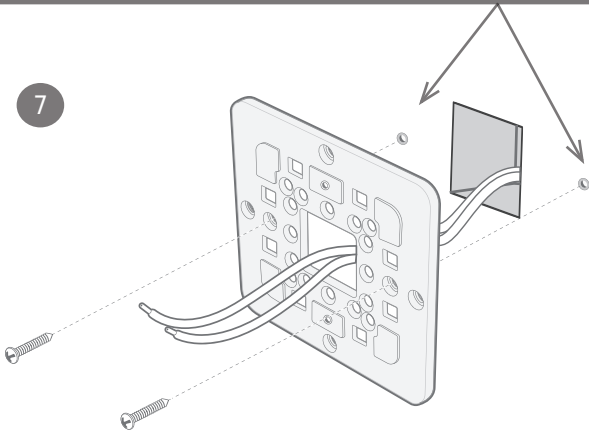



FR

8

A

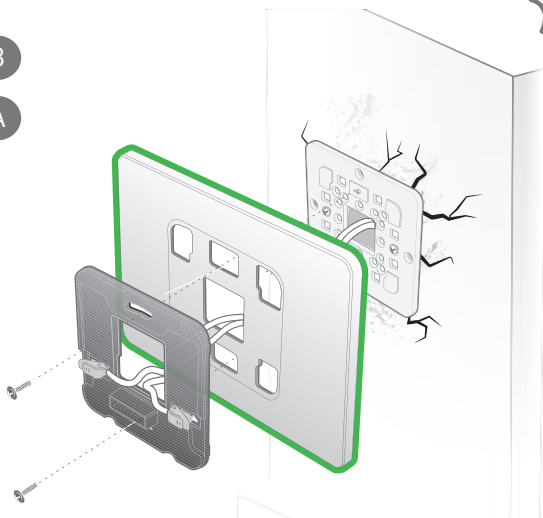

8

B

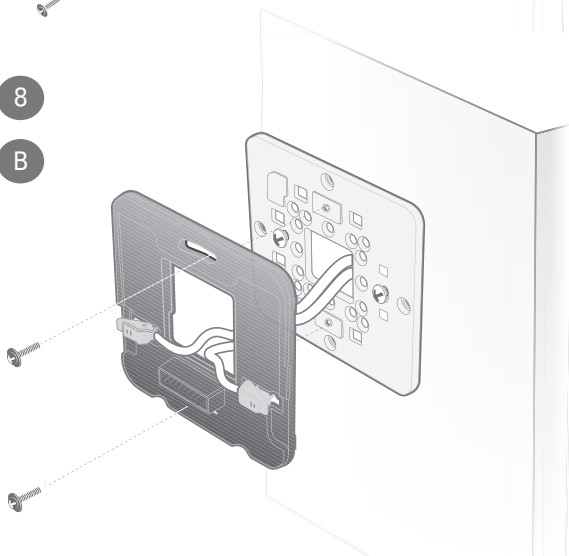



FR

9

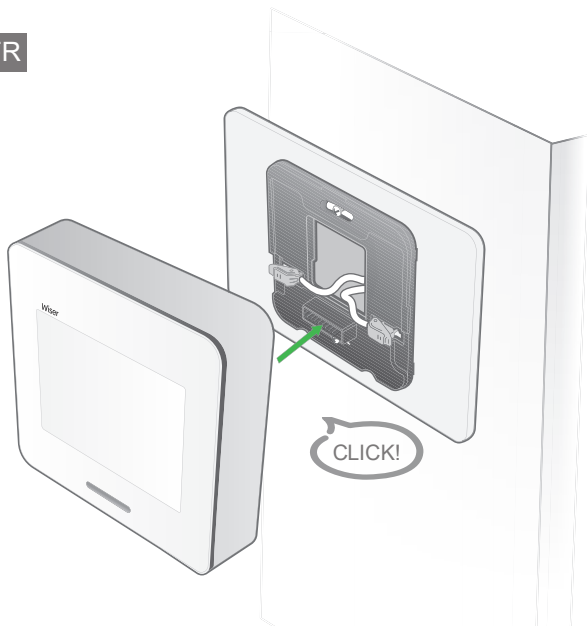







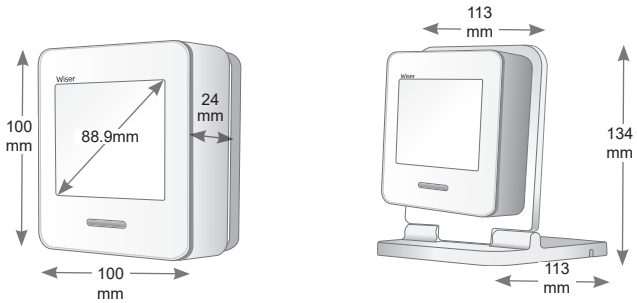

10



20-30s





| | |
|--|---|
|  24VDC 0.25A |  5.1VDC 1.2A |
|  0°C - 40°C  | |
| IP 20 | |
|  0% - 75% | |
|  Wi-Fi (802.11 b/g/n, 2.4GHz) | |
|  Wi-Fi Max RF 40 mW | |

EN

EU Declaration of conformity

Hereby, Schneider Electric Industries, declares that this product is in compliance with the essential requirements and other relevant provisions of RADIO EQUIPMENT DIRECTIVE 2014/53/EU. Declaration of conformity can be downloaded on: schneider-electric.com/docs.

FR

Déclaration de conformité UE

Par la présente, Schneider Electric Industries, déclare que ce produit est conforme aux exigences essentielles et aux autres dispositions pertinentes de la DIRECTIVE SUR L'EQUIPEMENT RADIO 2014/53/UE. La déclaration de conformité peut être téléchargée sur: schneider-electric.com/docs.

DE

EU-Konformitätserklärung

Schneider Electric Industries erklärt hiermit, dass dieses Produkt die grundlegenden Anforderungen sowie anderen relevanten Bestimmungen der FUNKLAGENRICHTLINIE 2014/53/EU erfüllt. Die Konformitätserklärung kann hier heruntergeladen werden: schneider-electric.com/docs.

NL

EU-verklaring van overeenstemming

Schneider Electric Industries verklaart hierbij dat dit product voldoet aan de essentiële vereisten en andere relevante bepalingen van RICHTLIJN 2014/53/EU VOOR RADIOAPPARATUUR. De verklaring van overeenstemming kan worden gedownload via: schneider-electric.com/docs.

DA

EU-overensstemmelseserklæring

Schneider Electric Industries erklærer hermed, at dette produkt er i overensstemmelse med de væsentlige krav og andre relevante bestemmelser i DIREKTIV 2014/53/EU OM RADIOUDSTYR. Overensstemmelseserklæringen kan downloades på: schneider-electric.com/docs.

SV

EU-försäkran om överensstämmelse

Härmed försäkras Schneider Electric Industries att denna produkt överensstämmer med de väsentliga kraven och andra relevanta bestämmelser i RADIOUTRUSTNINGSDIREKTIVET 2014/53/EU. Försäkran om överensstämmelse kan laddas ned på följande adress: schneider-electric.com/docs.

FI

EY-vaatimusten mukaisuusvakuutus

Schneider Electric Industries vakuuttaa, että tämä tuote vastaa RADIOLAITEDIREKTIIVIN 2014/53/EU olennaisia vaatimuksia ja muita keskeisiä säännöksiä. Vaatimusten mukaisuusvakuutuksen voi ladata sivulta schneider-electric.com/docs.

NO

EU samsvarserklæring

Schneider Electric Industries erklærer herved at dette produktet er i samsvar med hovedkrav og annet relevant regelverk i RADIOUTSTYRSDIREKTIVET 2014/53/EU. Samsvarserklæringen kan lastes ned her: schneider-electric.com/docs.

RU

Декларация соответствия ЕС

Настоящим Schneider Electric Industries заявляет, что данный продукт соответствует основным требованиям и другим соответствующим положениям ДИРЕКТИВЫ ПО РАДИООБОРУДОВАНИЮ 2014/53/ЕС. Декларацию соответствия можно загрузить по адресу: schneider-electric.com/docs.

KK

ЕО Сәйкестік туралы мәлімдемесі

Осы құжат арқылы Schneider Electric Industries осы бұйымның 2014/53/ЕО РАДИО ҚҰРЫЛҒЫ ДИРЕКТИВАСЫНЫҢ негізгі талаптары мен басқа да маңызды ережелеріне сәйкес келетінін хабарлайды. Сәйкестік туралы мәлімдемені мына жерден жүктеуге болады: schneider-electric.com/docs.

ES

Declaración UE de conformidad

Por la presente, Schneider Electric Industries declara que este producto cumple con los requisitos esenciales y otras disposiciones aplicables de la DIRECTIVA DE EQUIPOS RADIOELÉCTRICOS 2014/53/UE. La declaración de conformidad se puede descargar en: schneider-electric.com/docs.

IT

Dichiarazione di conformità UE

Schneider Electric Industries dichiara che questo prodotto è conforme ai requisiti essenziali e alle altre disposizioni pertinenti della DIRETTIVA SULLE APPARECCHIATURE RADIO (RED) 2014/53/UE. La dichiarazione di conformità può essere scaricata dal sito: schneider-electric.com/docs.



EN

Dispose of the device separately from household waste at an official collection point. Professional recycling protects people and the environment against potential negative effects.

FR

Ne pas jeter l'appareil avec les déchets ménagers ordinaires mais le mettre au rebut en le déposant dans un centre de collecte publique. Un recyclage professionnel protège les personnes et l'environnement contre de potentiels effets négatifs.

DE

Entsorgen Sie das Gerät getrennt vom Hausmüll bei einer offiziellen Sammelstelle. Eine fachgerechte Wiederverwertung schützt Mensch und Umwelt vor möglichen negativen Folgen.

NL

Het apparaat niet met het huishoudelijk afval afvoeren maar naar een officieel verzamelpunt brengen. Professionele recycling beschermt mens en milieu tegen potentiële negatieve effecten.

DA

Bortskaf apparatet separat fra husholdningsaffaldet på et officielt deponeringssted. Professionelt genbrug beskytter personer og miljøet mod potentielle negative effekter.

SV

Återvinn utrustningen separat från hushållsavfallet vid ett officiellt uppsamlingsställe. Professionell återvinning skyddar människor och miljö mot de negativa effekter som kan uppstå.

FI

Toimita laite kotitalousjätteistä erotettuna viralliseen jätteiden vastaanottopisteeseen. Ammattimainen kierrätys suojelee ihmisiä ja ympäristöä mahdollisesti haitallisilta vaikutuksilta.

NO

Ikke kast apparatet i det vanlige husholdningsavfallet, men lever det på et offentlig innsamlingssted. Profesjonell gjenvinning beskytter mennesker og miljø mot mulige negative effekter.

RU

Утилизацию устройства выполнять отдельно от бытовых отходов в официально установленных пунктах сбора. Профессиональная вторичная переработка защищает людей и окружающую среду от возможных негативных воздействий.

KK

Құрылғы мамандандырылған бөлімшеде тұрмыстық қалдықтардан бөлек кәдеге жаратылады. Кәсіби кәдеге жарату адамдар мен қоршаған ортаға келтірілуі мүмкін теріс салдардың алдын алады.

ES

Elimine el dispositivo separado de la basura doméstica en los puntos de recogida oficiales. El reciclado profesional protege a las personas y al medioambiente de posibles efectos negativos.

IT

Non smaltire l'apparecchio con i rifiuti domestici, ma consegnarlo a un centro di raccolta ufficiale. Il riciclaggio professionale contribuisce alla tutela delle persone e dell'ambiente dagli eventuali effetti nocivi.



MEG5050-0000



MEG5050-0001

1



2



schneider-electric.com/wiser

Schneider Electric Industries SAS
schneider-electric.com/contact