



Cat 6_A



Cat 6_A



RJ11



RJ 45

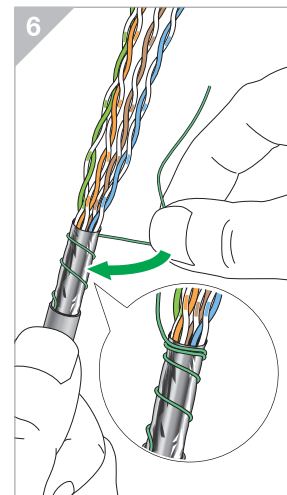
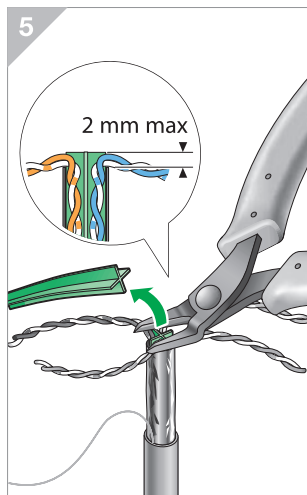
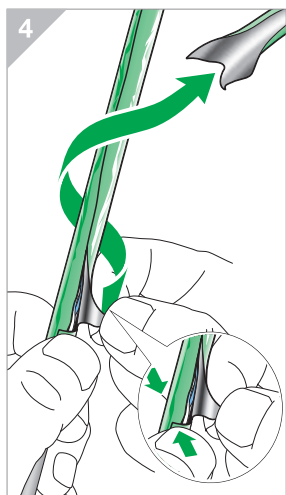
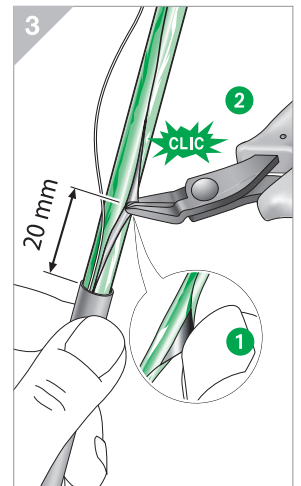
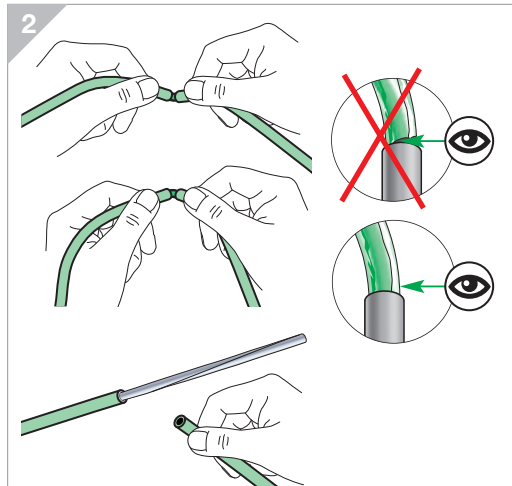
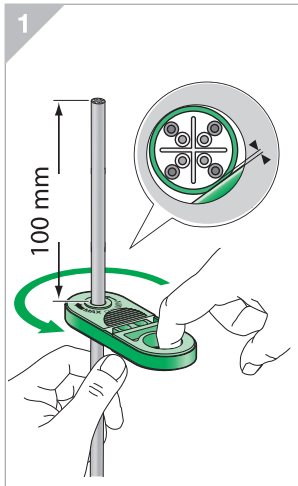
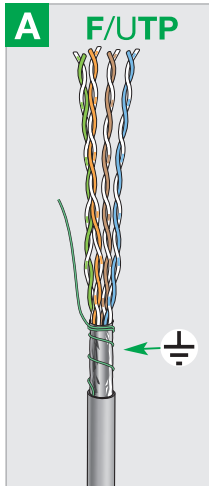
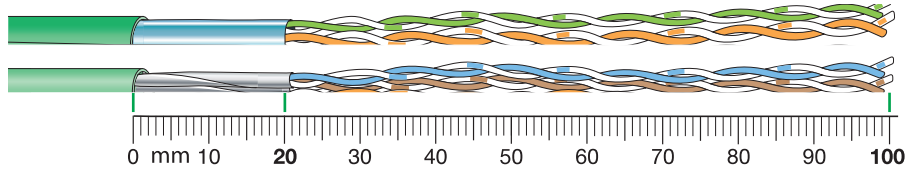

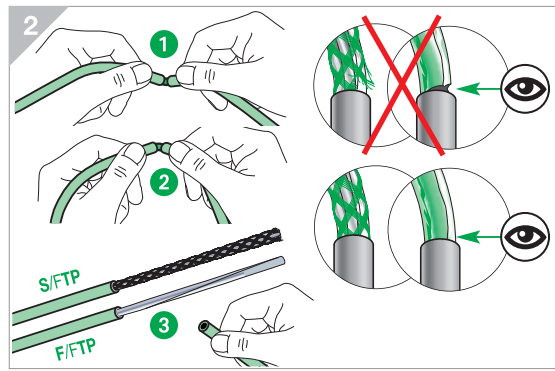
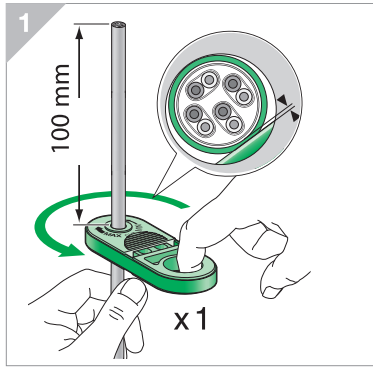
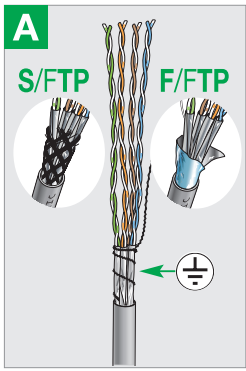

S/FTP ->

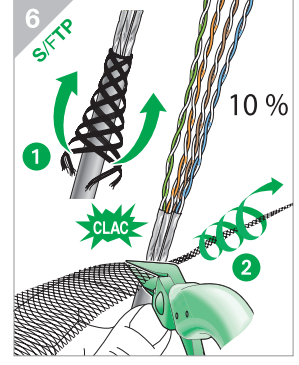
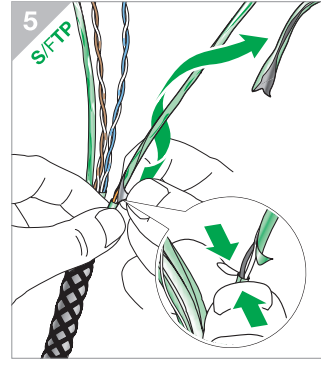
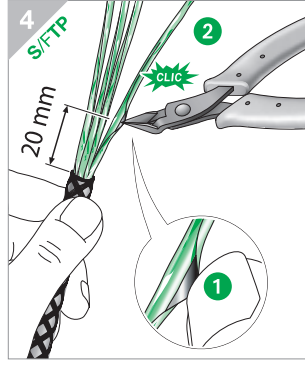
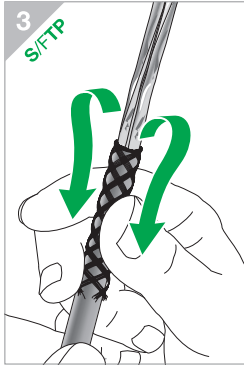

F/FTP ->

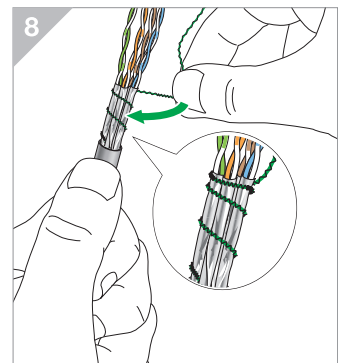
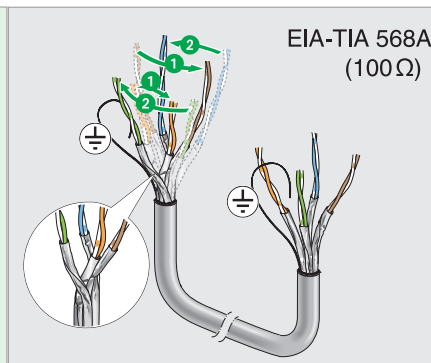
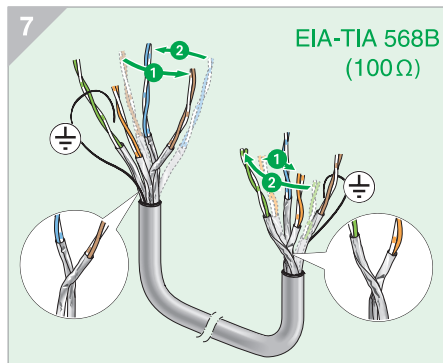
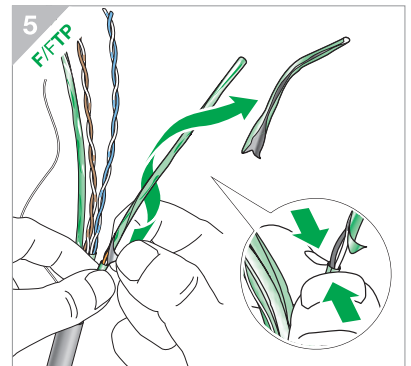
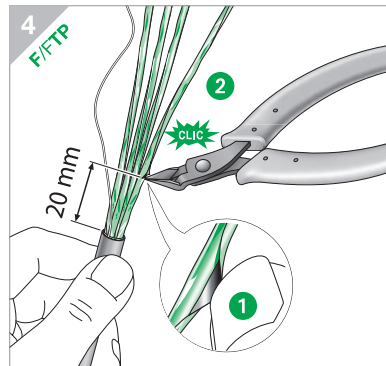
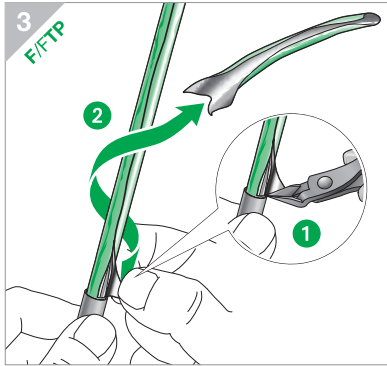

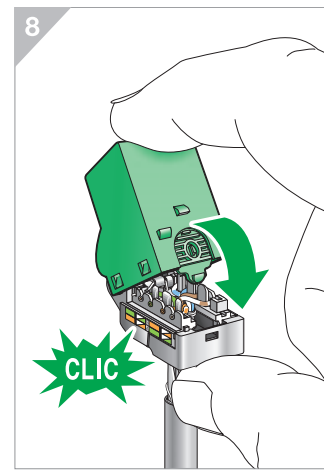
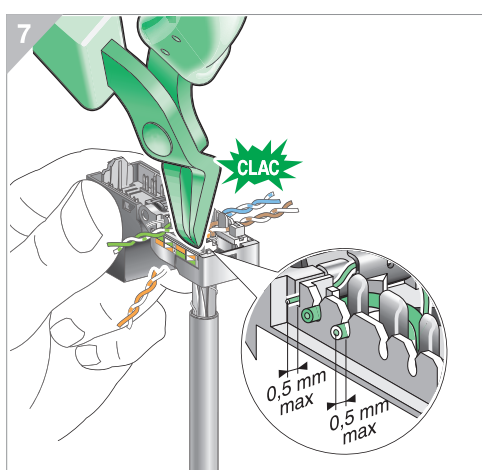
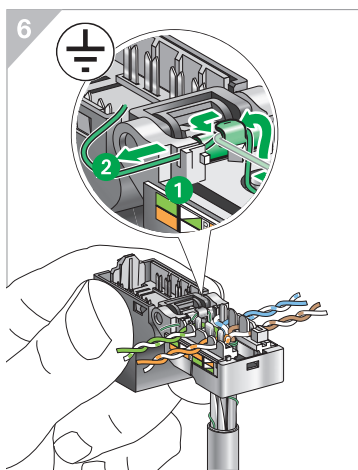
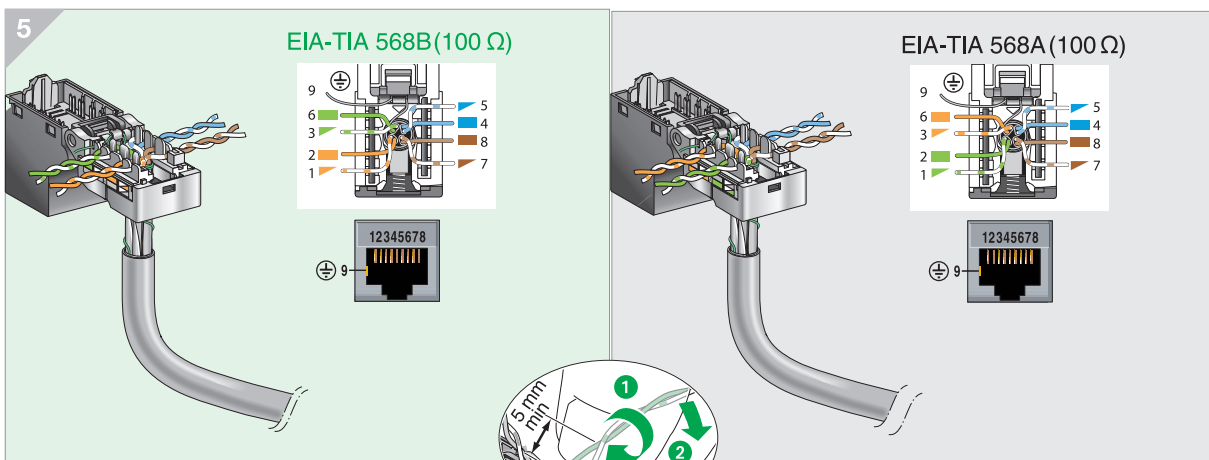
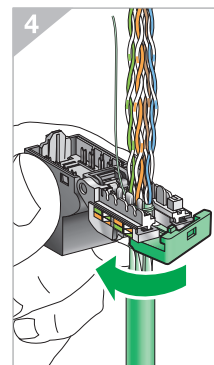
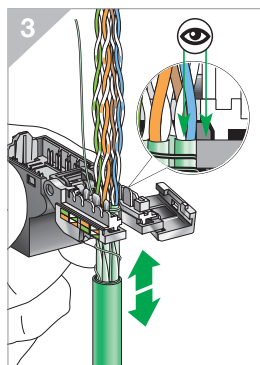
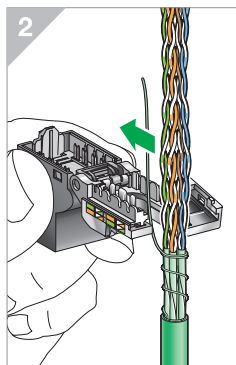
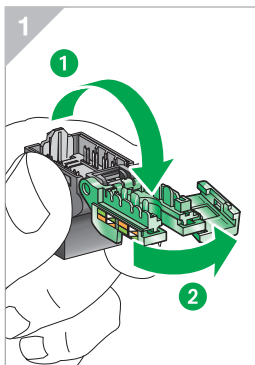
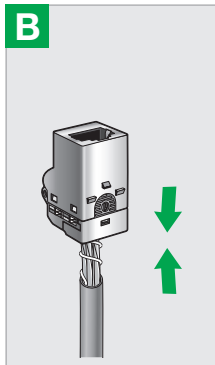

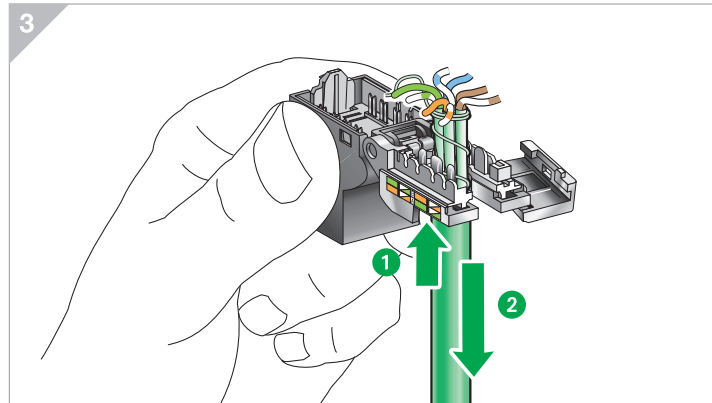
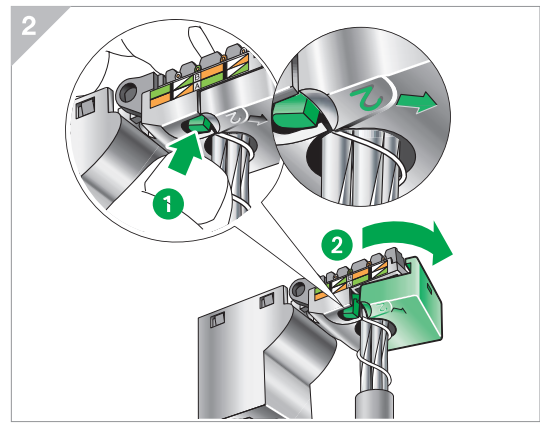
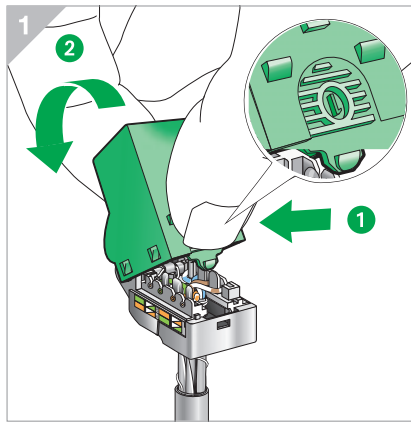
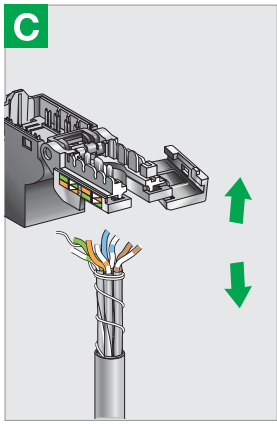

Schneider Electric GmbH c/o Merten

Gothaer Straße 29, 40880 Ratingen
 www.merten.de
 www.merten-austria.at

www.merten.com
 www.merten-austria.at

Kundenbetreuung:
 Telefon: +49 2102-404 6000

Customer care centre:
 Phone: +49 2102-404 6000